

## ELECTRICAL

THERE ARE NO ELECTRICAL COMPONENTS IN THIS UNIT.

## INSTALLATION INSTRUCTIONS ICE COOLED COLD PAN MODEL ICP-300

### CUTOUT DETAILS

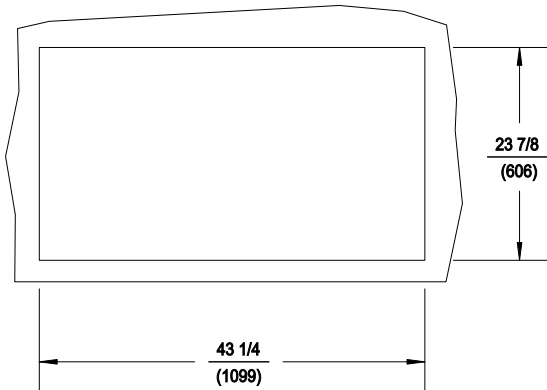

### PRODUCT DIMENSIONS

INCHES  
(MM)

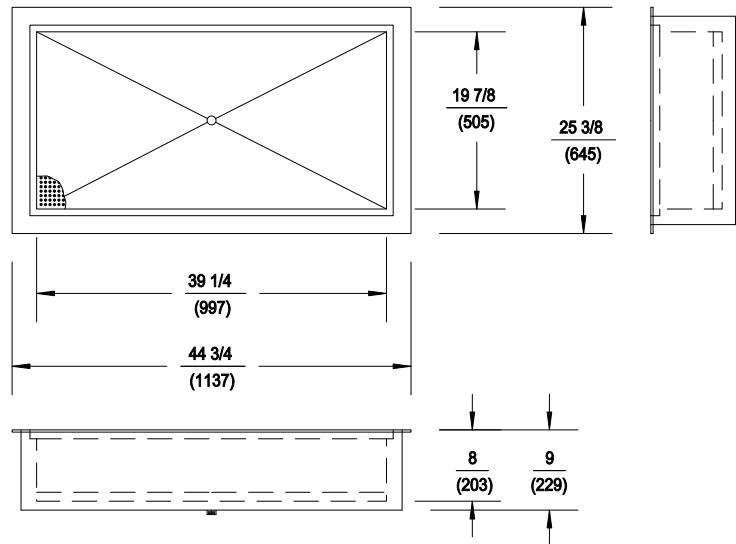

### CLEARANCES

THERE ARE NO CLEARANCE SPECIFICATIONS FOR THIS UNIT.

### INSTALLATION INSTRUCTIONS

INSTALLER MUST MEET CONDITIONS OF ACCEPTABILITY OUTLINED BELOW UPON INSTALLATION:

TO INSTALL:

1. Lay out "cutout" dimensions on countertop or table.
  2. Cut out hole and add stiffeners to support weight of unit if necessary. Countertop must be flat and level before installing cold pan.
  3. apply a generous bead of silicone sealant to underside of mounting flange before setting unit into cutout. Remove any excess sealant from top flange and countertop.
  4. Connect 1 inch drain to drain pan or floor drain.
- Consult local codes for approved drain connections.

